

Complementary Silicon Plastic Power Transistors

... designed for use as high-frequency drivers in audio amplifiers.

- DC Current Gain Specified to 4.0 Amperes
 $h_{FE} = 40$ (Min) @ $I_C = 3.0$ Adc
 $= 20$ (Min) @ $I_C = 4.0$ Adc
- Collector-Emitter Sustaining Voltage —
 $V_{CEO(sus)} = 120$ Vdc (Min) — MJE15028, MJE15029
 $= 150$ Vdc (Min) — MJE15030, MJE15031
- High Current Gain — Bandwidth Product
 $f_T = 30$ MHz (Min) @ $I_C = 500$ mAdc
- TO-220AB Compact Package

MAXIMUM RATINGS

Rating	Symbol	MJE15028 MJE15029	MJE15030 MJE15031	Unit
Collector-Emitter Voltage	V_{CEO}	120	150	Vdc
Collector-Base Voltage	V_{CB}	120	150	Vdc
Emitter-Base Voltage	V_{EB}	5.0		Vdc
Collector Current — Continuous — Peak	I_C	8.0 16		Adc
Base Current	I_B	2.0		Adc
Total Power Dissipation @ $T_C = 25^\circ\text{C}$ Derate above 25°C	P_D	50 0.40		Watts W/ $^\circ\text{C}$
Total Power Dissipation @ $T_A = 25^\circ\text{C}$ Derate above 25°C	P_D	2.0 0.016		Watts W/ $^\circ\text{C}$
Operating and Storage Junction Temperature Range	T_J, T_{stg}	-65 to +150		$^\circ\text{C}$

THERMAL CHARACTERISTICS

Characteristic	Symbol	Max	Unit
Thermal Resistance, Junction to Case	$R_{\theta JC}$	2.5	$^\circ\text{C/W}$
Thermal Resistance, Junction to Ambient	$R_{\theta JA}$	62.5	$^\circ\text{C/W}$

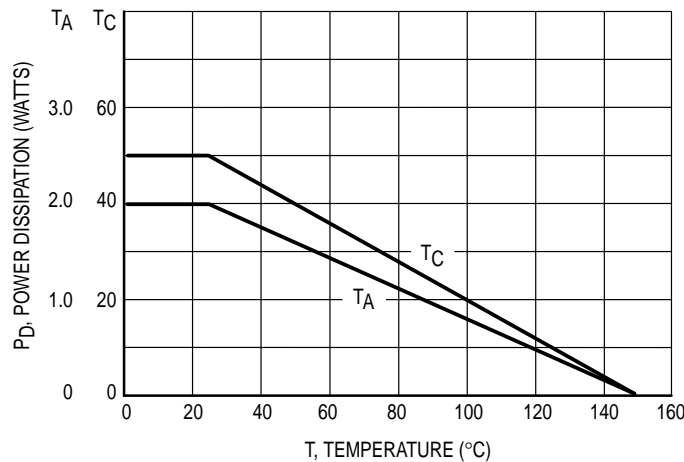

Figure 1. Power Derating

Preferred devices are Motorola recommended choices for future use and best overall value.

NPN
MJE15028*
MJE15030*
PNP
MJE15029*
MJE15031*

*Motorola Preferred Device

8 AMPERE
POWER TRANSISTORS
COMPLEMENTARY
SILICON
120-150 VOLTS
50 WATTS

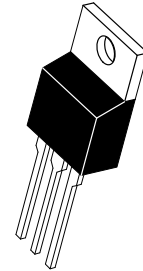

CASE 221A-06
TO-220AB

MJE15028 MJE15030 MJE15029 MJE15031

ELECTRICAL CHARACTERISTICS ($T_C = 25^\circ\text{C}$ unless otherwise noted)

Characteristic	Symbol	Min	Max	Unit
OFF CHARACTERISTICS				
Collector–Emitter Sustaining Voltage (1) ($I_C = 10\text{ mAdc}$, $I_B = 0$)	$V_{CE(sus)}$	120 150	— —	Vdc
Collector Cutoff Current ($V_{CE} = 120\text{ Vdc}$, $I_B = 0$) ($V_{CE} = 150\text{ Vdc}$, $I_B = 0$)	I_{CEO}	— —	0.1 0.1	mAdc
Collector Cutoff Current ($V_{CB} = 120\text{ Vdc}$, $I_E = 0$) ($V_{CB} = 150\text{ Vdc}$, $I_E = 0$)	I_{CBO}	— —	10 10	μAdc
Emitter Cutoff Current ($V_{BE} = 5.0\text{ Vdc}$, $I_C = 0$)	I_{EBO}	—	10	μAdc

ON CHARACTERISTICS (1)

DC Current Gain ($I_C = 0.1\text{ Adc}$, $V_{CE} = 2.0\text{ Vdc}$) ($I_C = 2.0\text{ Adc}$, $V_{CE} = 2.0\text{ Vdc}$) ($I_C = 3.0\text{ Adc}$, $V_{CE} = 2.0\text{ Vdc}$) ($I_C = 4.0\text{ Adc}$, $V_{CE} = 2.0\text{ Vdc}$)	h_{FE}	40 40 40 20	— — — —	—
DC Current Gain Linearity (V_{CE} From 2.0 V to 20 V, I_C From 0.1 A to 3 A) (NPN TO PNP)	h_{FE}	Typ 2 3		
Collector–Emitter Saturation Voltage ($I_C = 1.0\text{ Adc}$, $I_B = 0.1\text{ Adc}$)	$V_{CE(sat)}$	—	0.5	Vdc
Base–Emitter On Voltage ($I_C = 1.0\text{ Adc}$, $V_{CE} = 2.0\text{ Vdc}$)	$V_{BE(on)}$	—	1.0	Vdc

DYNAMIC CHARACTERISTICS

Current Gain — Bandwidth Product (2) ($I_C = 500\text{ mAdc}$, $V_{CE} = 10\text{ Vdc}$, $f_{test} = 10\text{ MHz}$)	f_T	30	—	MHz
---	-------	----	---	-----

- (1) Pulse Test: Pulse Width $\leq 300\ \mu\text{s}$, Duty Cycle $\leq 2.0\%$.
- (2) $f_T = |h_{fe}| \cdot f_{test}$.

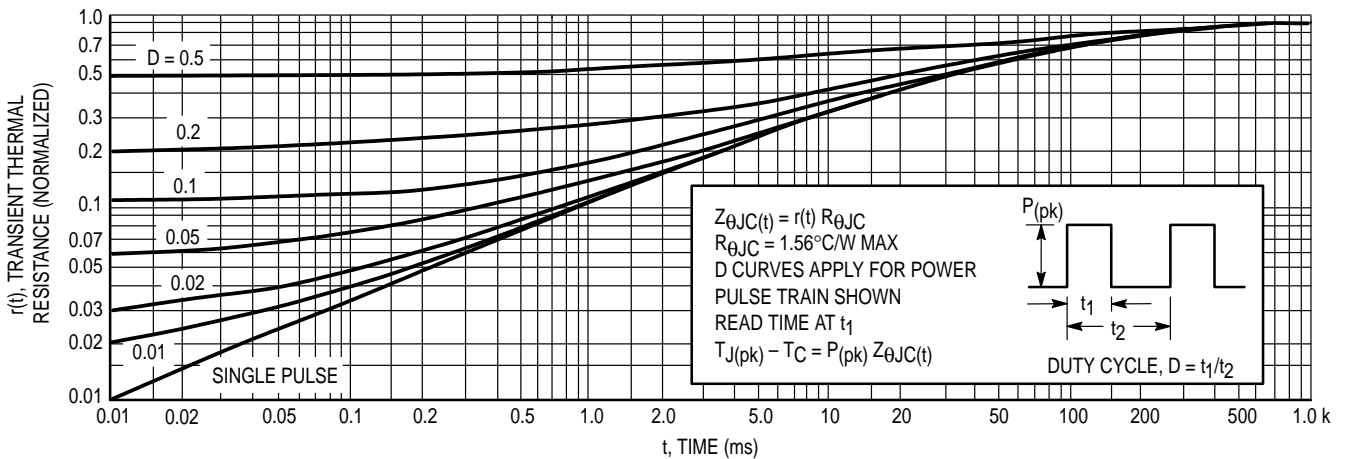

Figure 2. Thermal Response

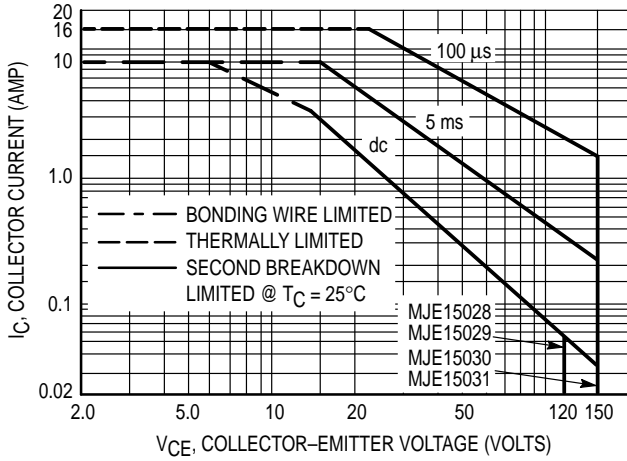

Figure 3. Forward Bias Safe Operating Area

There are two limitations on the power handling ability of a transistor: average junction temperature and second breakdown. Safe operating area curves indicate $I_C - V_{CE}$ limits of the transistor that must be observed for reliable operation, i.e., the transistor must not be subjected to greater dissipation than the curves indicate.

The data of Figures 3 and 4 is based on $T_{J(pk)} = 150^\circ\text{C}$; T_C is variable depending on conditions. Second breakdown pulse limits are valid for duty cycles to 10% provided $T_{J(pk)} < 150^\circ\text{C}$. $T_{J(pk)}$ may be calculated from the data in Figure 2. At high case temperatures, thermal limitations will reduce the power that can be handled to values less than the limitations imposed by second breakdown.

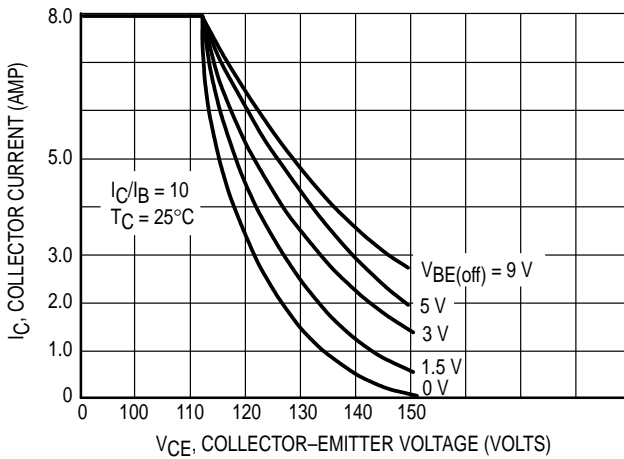

Figure 4. Reverse-Bias Switching Safe Operating Area

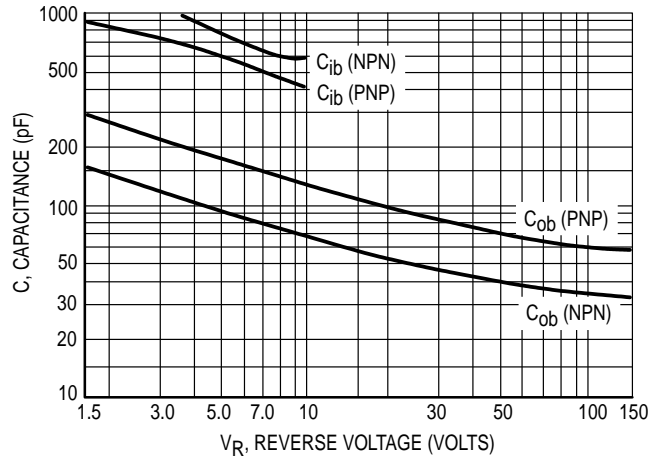

Figure 5. Capacitances

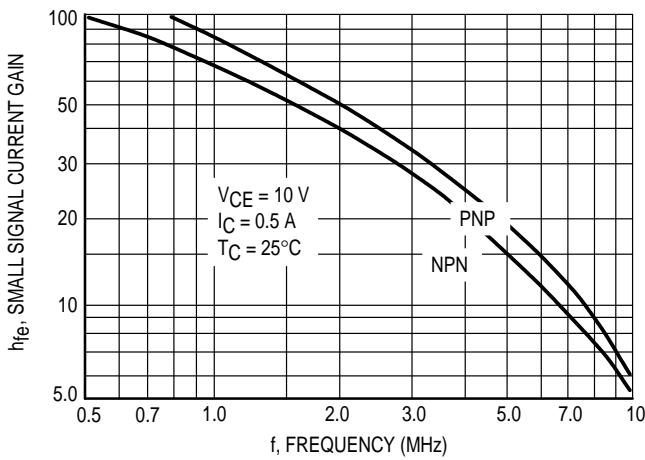

Figure 6. Small-Signal Current Gain

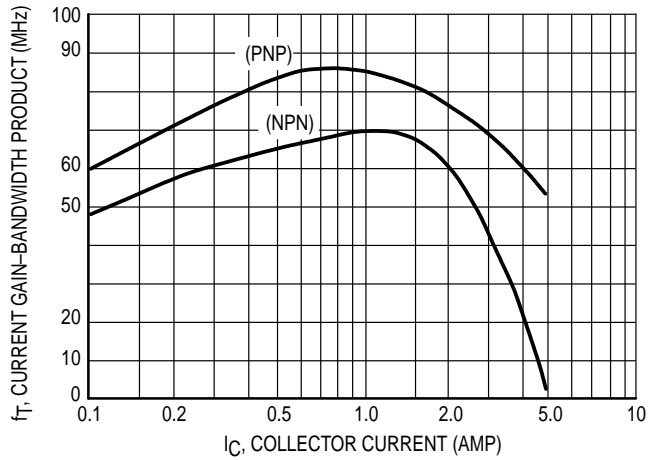
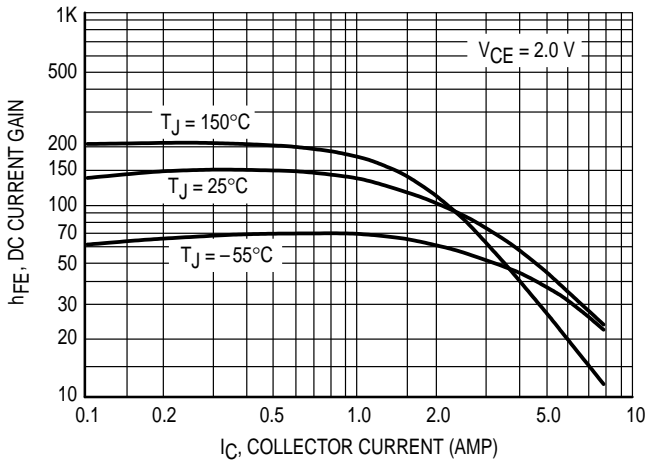

Figure 7. Current Gain-Bandwidth Product

NPN — MJE15028 MJE15030



PNP — MJE15029 MJE15031

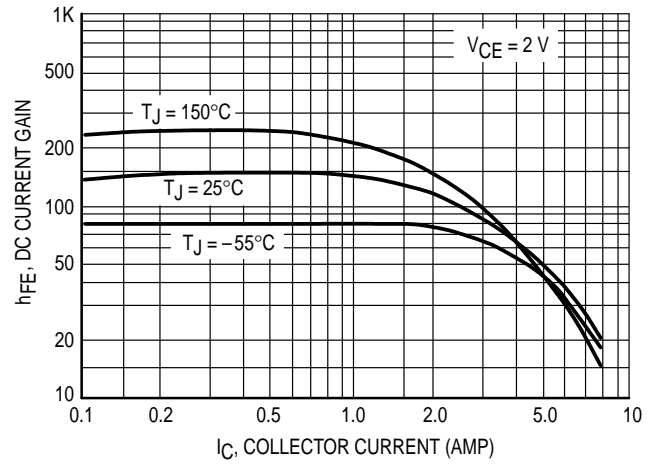
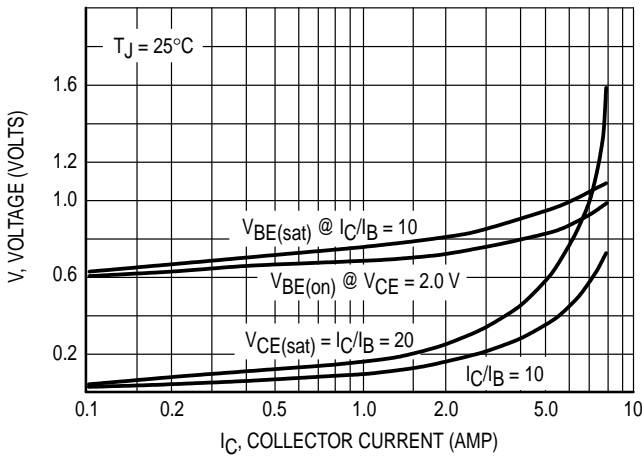

Figure 8. DC Current Gain

NPN



PNP

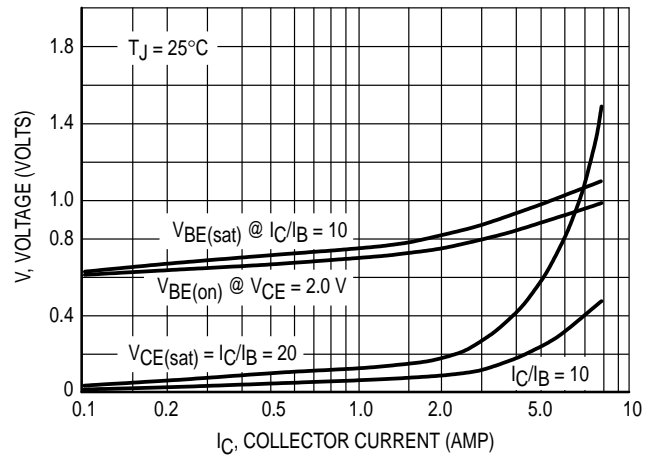

Figure 9. "On" Voltage

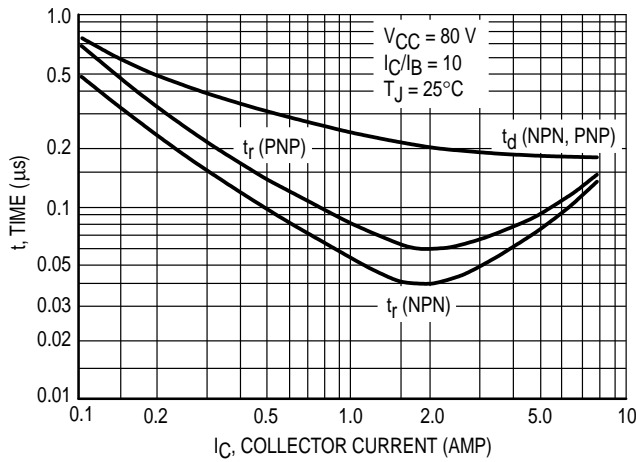

Figure 10. Turn-On Times

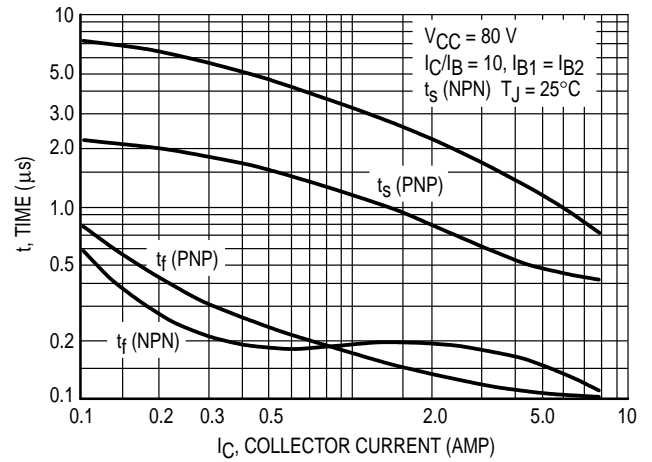
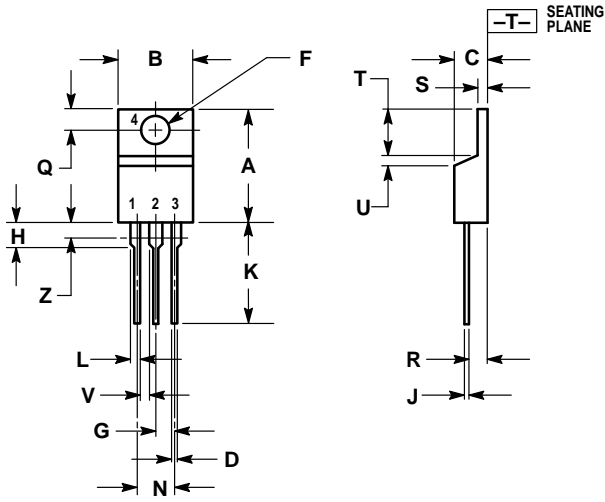

Figure 11. Turn-Off Times

PACKAGE DIMENSIONS



- NOTES:
1. DIMENSIONING AND TOLERANCING PER ANSI Y14.5M, 1982.
 2. CONTROLLING DIMENSION: INCH.
 3. DIMENSION Z DEFINES A ZONE WHERE ALL BODY AND LEAD IRREGULARITIES ARE ALLOWED.

DIM	INCHES		MILLIMETERS	
	MIN	MAX	MIN	MAX
A	0.570	0.620	14.48	15.75
B	0.380	0.405	9.66	10.28
C	0.160	0.190	4.07	4.82
D	0.025	0.035	0.64	0.88
F	0.142	0.147	3.61	3.73
G	0.095	0.105	2.42	2.66
H	0.110	0.155	2.80	3.93
J	0.018	0.025	0.46	0.64
K	0.500	0.562	12.70	14.27
L	0.045	0.060	1.15	1.52
N	0.190	0.210	4.83	5.33
Q	0.100	0.120	2.54	3.04
R	0.080	0.110	2.04	2.79
S	0.045	0.055	1.15	1.39
T	0.235	0.255	5.97	6.47
U	0.000	0.050	0.00	1.27
V	0.045	—	1.15	—
Z	—	0.080	—	2.04

- STYLE 1:
- PIN 1. BASE
 - COLLECTOR
 - EMITTER
 - COLLECTOR

CASE 221A-06
TO-220AB
ISSUE Y

Motorola reserves the right to make changes without further notice to any products herein. Motorola makes no warranty, representation or guarantee regarding the suitability of its products for any particular purpose, nor does Motorola assume any liability arising out of the application or use of any product or circuit, and specifically disclaims any and all liability, including without limitation consequential or incidental damages. "Typical" parameters can and do vary in different applications. All operating parameters, including "Typicals" must be validated for each customer application by customer's technical experts. Motorola does not convey any license under its patent rights nor the rights of others. Motorola products are not designed, intended, or authorized for use as components in systems intended for surgical implant into the body, or other applications intended to support or sustain life, or for any other application in which the failure of the Motorola product could create a situation where personal injury or death may occur. Should Buyer purchase or use Motorola products for any such unintended or unauthorized application, Buyer shall indemnify and hold Motorola and its officers, employees, subsidiaries, affiliates, and distributors harmless against all claims, costs, damages, and expenses, and reasonable attorney fees arising out of, directly or indirectly, any claim of personal injury or death associated with such unintended or unauthorized use, even if such claim alleges that Motorola was negligent regarding the design or manufacture of the part. Motorola and  are registered trademarks of Motorola, Inc. Motorola, Inc. is an Equal Opportunity/Affirmative Action Employer.

How to reach us:

USA / EUROPE: Motorola Literature Distribution;
P.O. Box 20912; Phoenix, Arizona 85036. 1-800-441-2447

JAPAN: Nippon Motorola Ltd.; Tatsumi-SPD-JLDC, Toshikatsu Otsuki,
6F Seibu-Butsuryu-Center, 3-14-2 Tatsumi Koto-Ku, Tokyo 135, Japan. 03-3521-8315

MFAX: RMFAX0@email.sps.mot.com – TOUCHTONE (602) 244-6609
INTERNET: <http://Design-NET.com>

HONG KONG: Motorola Semiconductors H.K. Ltd.; 8B Tai Ping Industrial Park,
51 Ting Kok Road, Tai Po, N.T., Hong Kong. 852-26629298

